

***advanced FLOW engineering*** Black Series Cold Air Intake System

**Instruction Manual** P/N: 58-10007D / 58-10007R

Make: CHEVROLET

Model: CORVETTE (C8)

Year: 2020-2021

Engine: V8-6.2L



- Please read the entire instruction manual before proceeding.
- Ensure all components listed are present.
- If you are missing any of the components, call customer support at 951-493-7185.
- Ensure you have all necessary tools before proceeding.
- Do not attempt to work on your vehicle when the engine is hot.
- Retain factory parts for future use.

Label	Qty.	Description	Part Number
A1	2	Air Filter, P5R (For 58-10007R Only)	24-91020
A2	2	Air Filter, PDS (For 58-10007D Only)	21-91020
B	1	Tube, Carbon Fiber	05-5710013C1
C	1	Housing, Plastic*	05-5810007B2
D	1	Flange Inlet, Plastic (Driver Side)	05-5710013B3
E	1	Flange Inlet, Plastic (Passenger Side)	05-5710013B4
F	1	Worm Clamp, #064	03-50006
G	1	Worm Clamp, #072	03-50010
H	2	Coupling Silicone Bellows, 5"ID	05-01573
I	1	Coupling Silicone, Throttle Body	05-01570
J	1	Sleeve Silicone, Carbon Fiber Tube	05-01574
K	1	Fitting, 5/8" QD Male to 3/4" Push-on, 90 Deg	05-01576
L	1	Spring Band Clamp	03-50646
M	1	Cover, Carbon Fiber*	05-5810007C3
N	8	Screw, aFe POWER Laser Etched*	03-50483
O	6	Screw, Button Head: M6x10mm	03-50113
P	6	Washer: M6	03-50750
Q	4	Screw, Torx: M4x10mm	03-50490
R	3	Cable Ties, Nylon	03-50492

**Installation will require the following tools:** T15, T20 and T30 Torx bits/drivers, 7mm, 8mm, 10mm nut drivers/sockets and ratchet, flathead screwdrivers, trim removal tool, razor blade, 3mm and 4mm Hex Key, and pliers.

Warranty Information available at <https://afepower.com/contact#warranty>

**Emissions Disclaimer:** This product is not currently CARB exempt and is not available for purchase in California or for use on any vehicle registered with the California Department of Motor Vehicles.

\*Housing, cover, and screws comes assembled together for perfect fitment

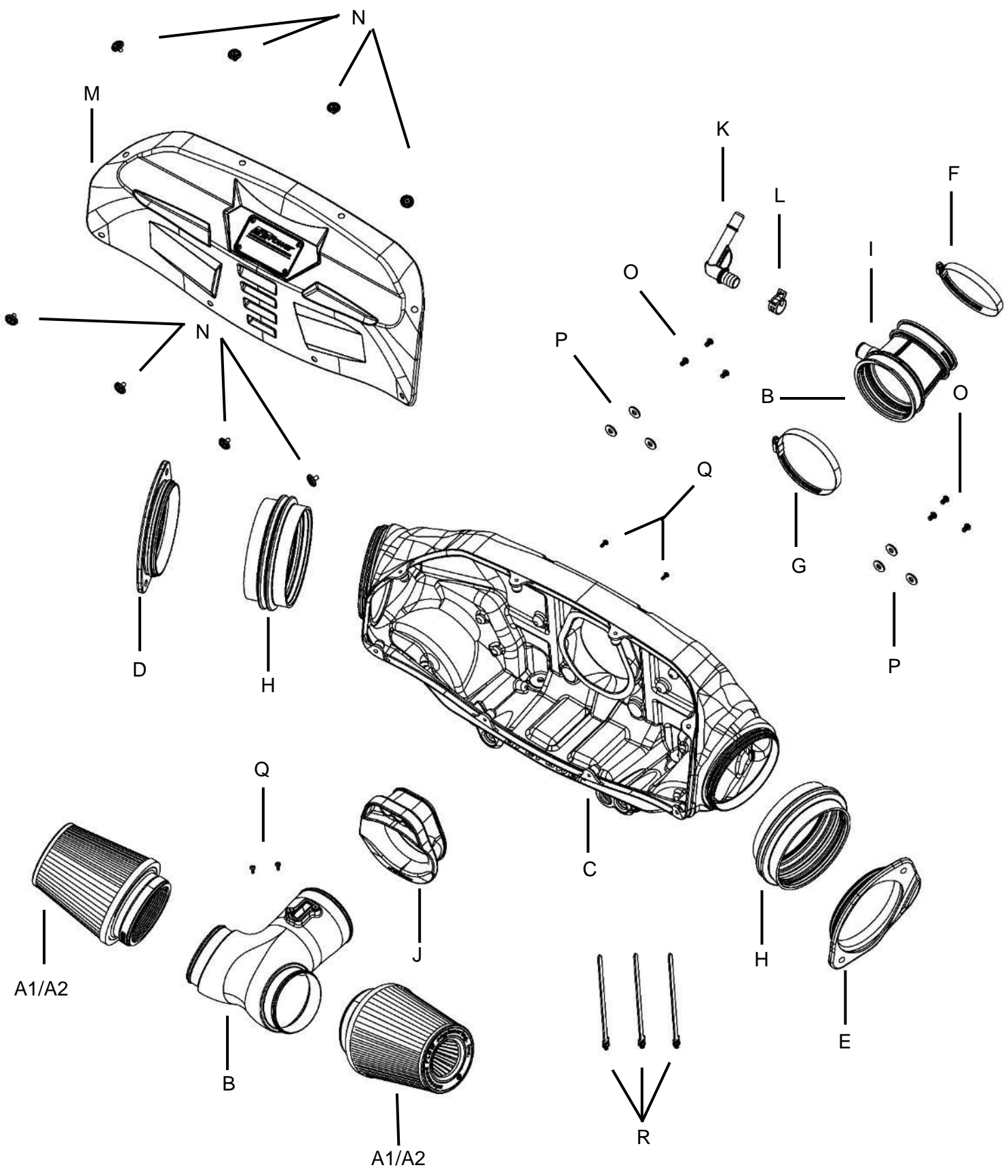





**Figure A**

**Refer to Figure A for Step 1**

Step 1: Open the trunk and remove the seal trim surrounding the trunk.

**Figure B****Refer to Figure B for Step 2**

Step 2: Remove the (8) T15 screws securing the roof latches on the driver side and the passenger side.





**Figure C**

**Refer to Figure C for Steps 3-5**

Step 3: Unscrew and remove the (2) cargo net hooks (one on the driver side and one on the passenger side.)

Step 4: Remove the (4) push clips securing the carpet (2 on the driver side and 2 on the passenger side.)

Step 5: Remove the carpet to gain access to the engine.

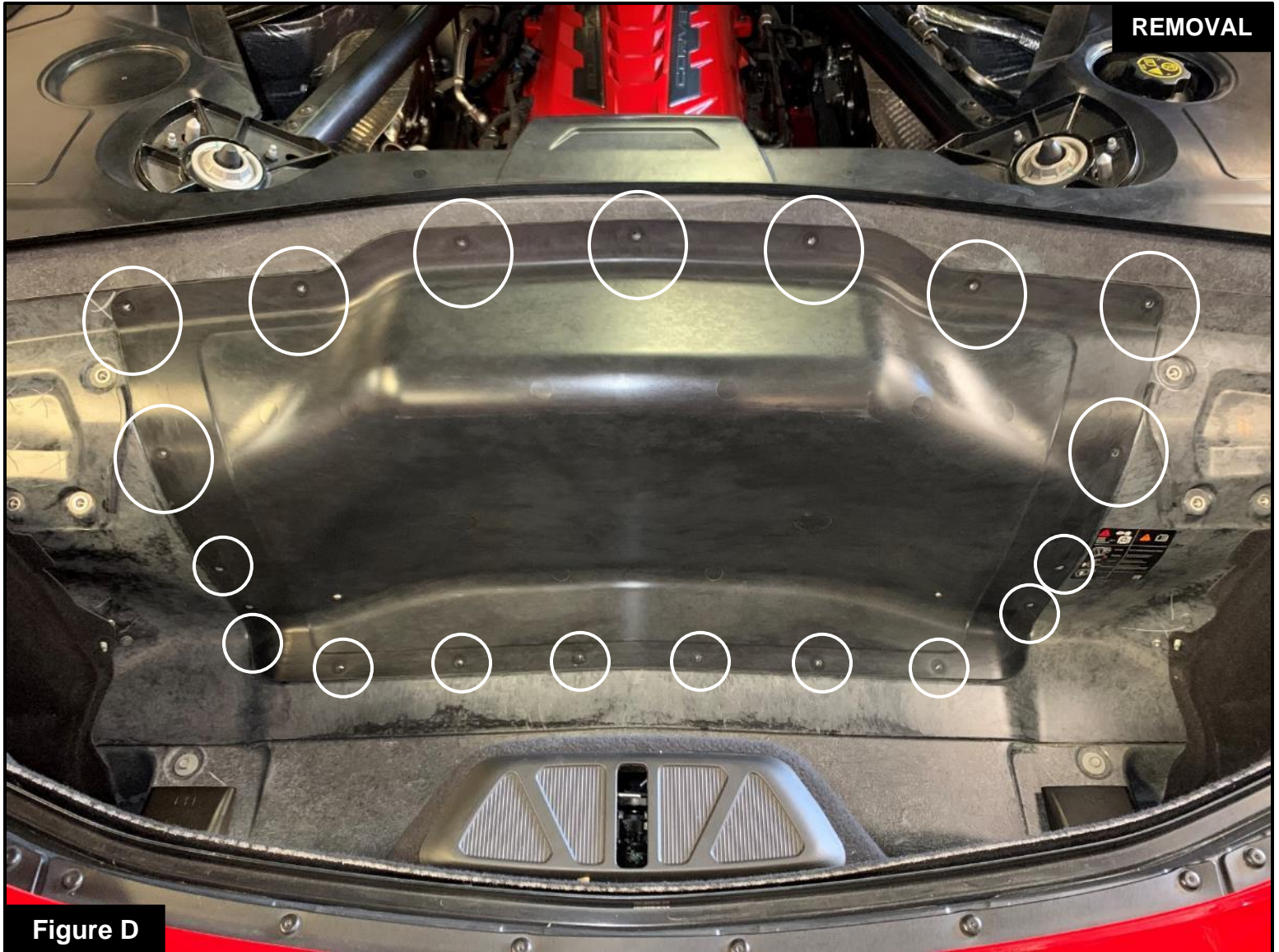

Figure D

**Refer to Figure D for Steps 6-7**

Step 6: Remove the T15 screws securing the plastic engine cover.

Step 7: Then remove the plastic engine cover to gain access to the factory air box.



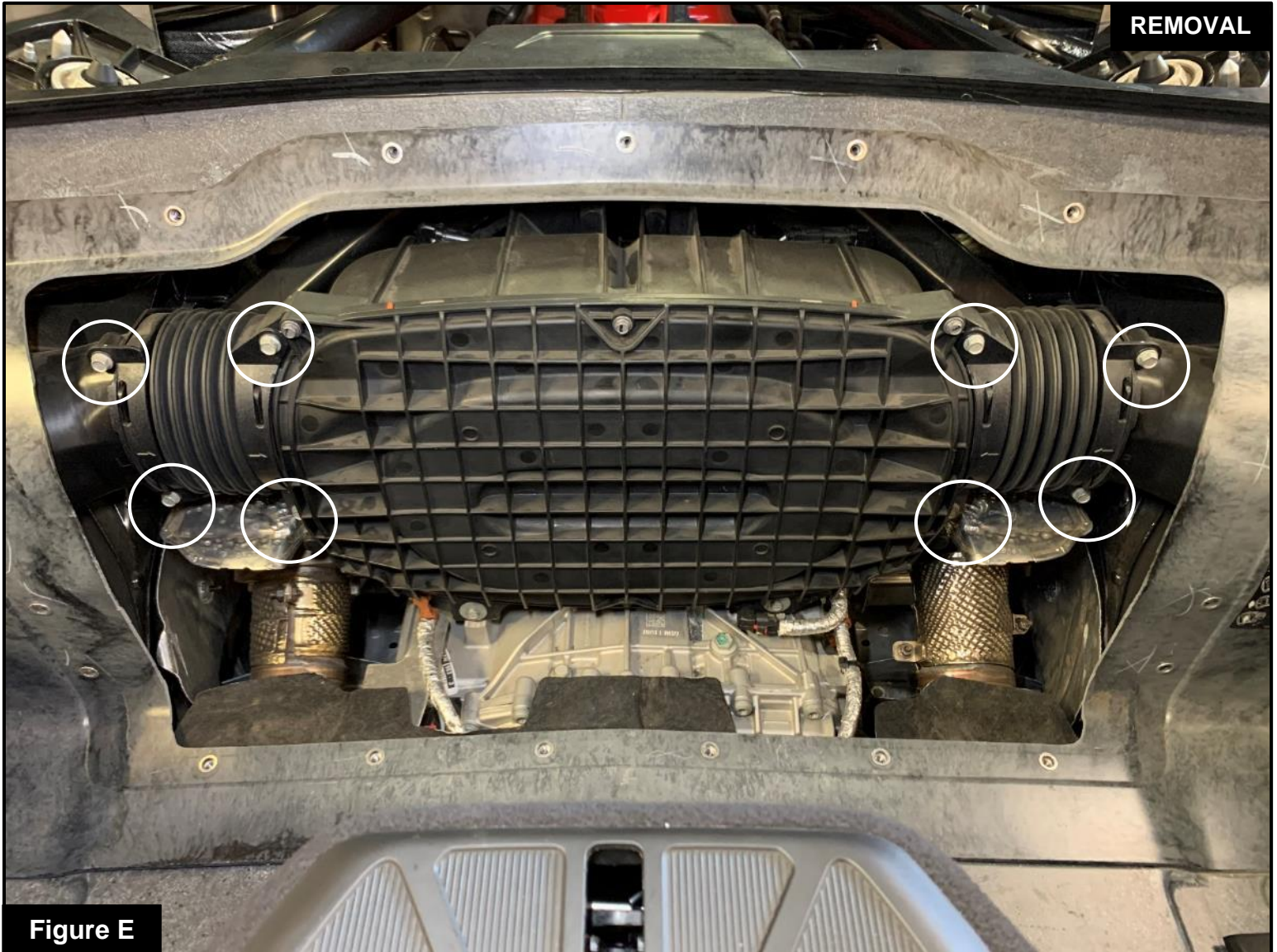

**Refer to Figure E for Step 8**

Step 8: Remove the (8) 10mm screws securing the left and right air inlet duct couplings and remove them from the air box. These screws will not be reused.



**Figure F****Refer to Figure F for Step 9**

Step 9: Locate the temperature sensor harness on the passenger side of the factory air box and disconnect the harness, by sliding back the red locking tab and then pressing down on the back tab.



**Figure G**

**Refer to Figure G for Steps 10-11**

Step 10: Remove the (2) 10mm screws securing the factory airbox to the transmission. These screws will be reused.

Step 11: Unclip the harnesses on both sides of the airbox.





**Refer to Figure H for Steps 12-13**

Step 12: From the engine side, remove the 10mm screw securing the factory airbox on the driver side. This screw will be reused.

Step 13: Unclip the harness from the airbox, at the three locations pictured.

**Figure I****Refer to Figure I for Steps 14-16**

Step 14: Remove the 10mm screw securing the airbox on the passenger side. This screw will be reused.

Step 15: Unclip the harness from the airbox, at the three locations pictured.

Step 16: Disconnect the Mass Air Flow sensor, by sliding back the white locking tab and then squeezing it while pulling it out.



**Figure J****Refer to Figure J for Step 17**

Step 17: Using a 7mm nut driver or flathead screwdriver, loosen the clamp securing the coupling to the airbox. Do not loosen clamp securing the coupling to the throttle body yet.

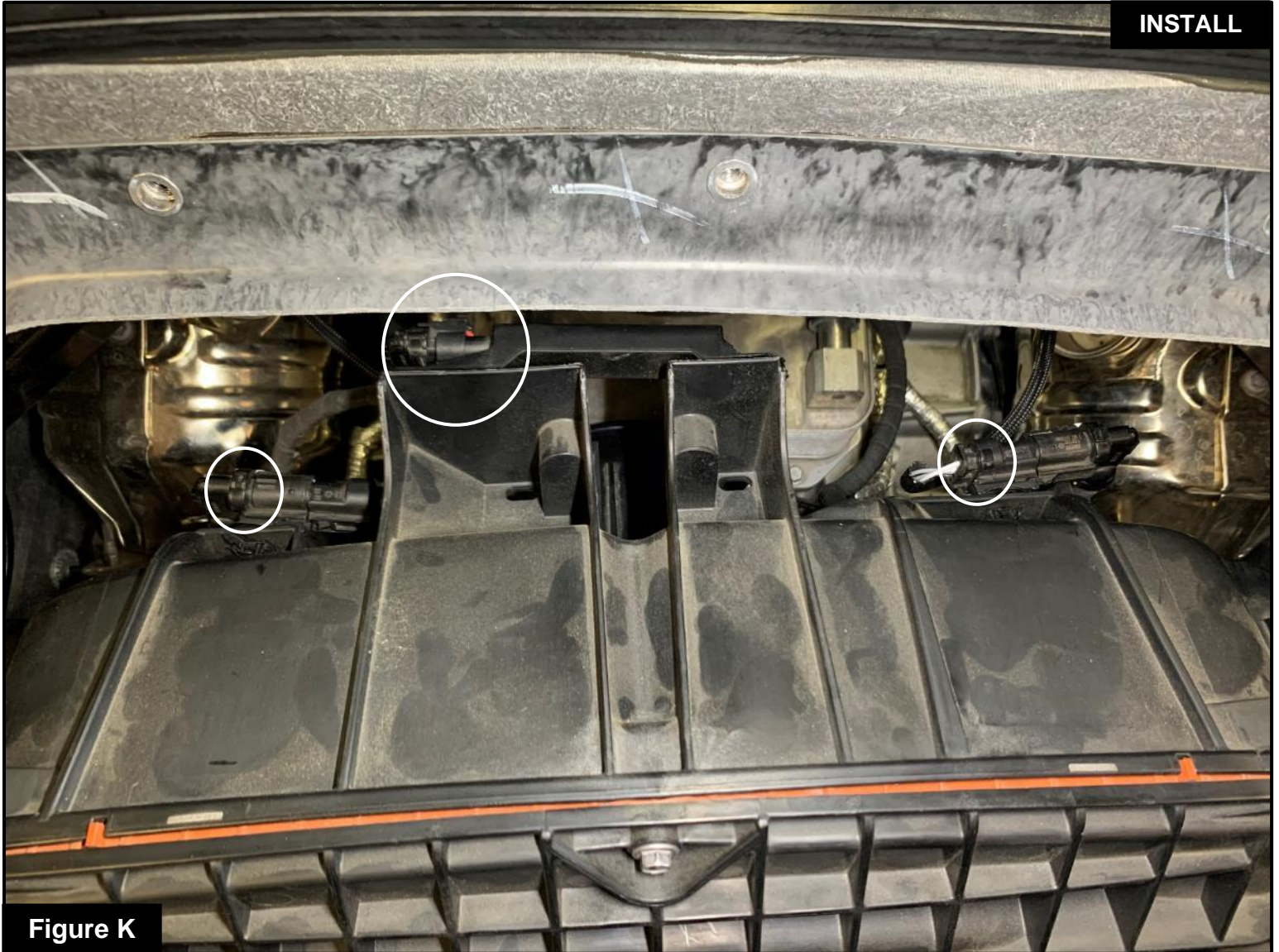
**Figure K****Refer to Figure K for Step 18**

Step 18: Move the airbox towards the rear of the vehicle, taking caution not to damage the remaining harnesses attached to the airbox. Once the housing is pulled back far enough, release the O2 sensor harnesses by pushing the clips out of the airbox, and disconnect the antenna connector.

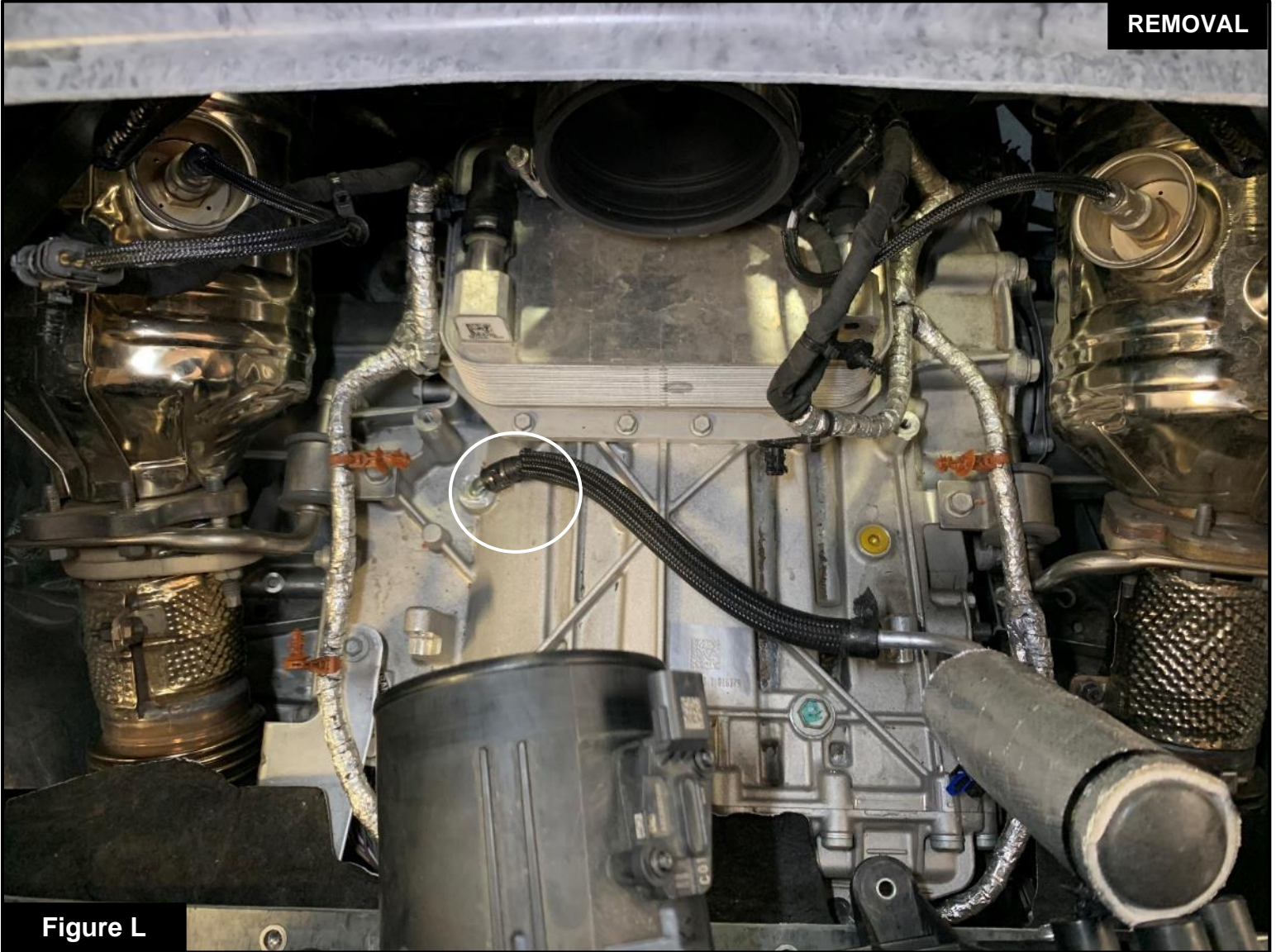

**Figure L****Refer to Figure L for Step 19**

Step 19: Carefully pull the airbox further towards the rear of the vehicle, and disconnect the rubber hose from the transmission using pliers to release the clamp. Remove the airbox from the vehicle.

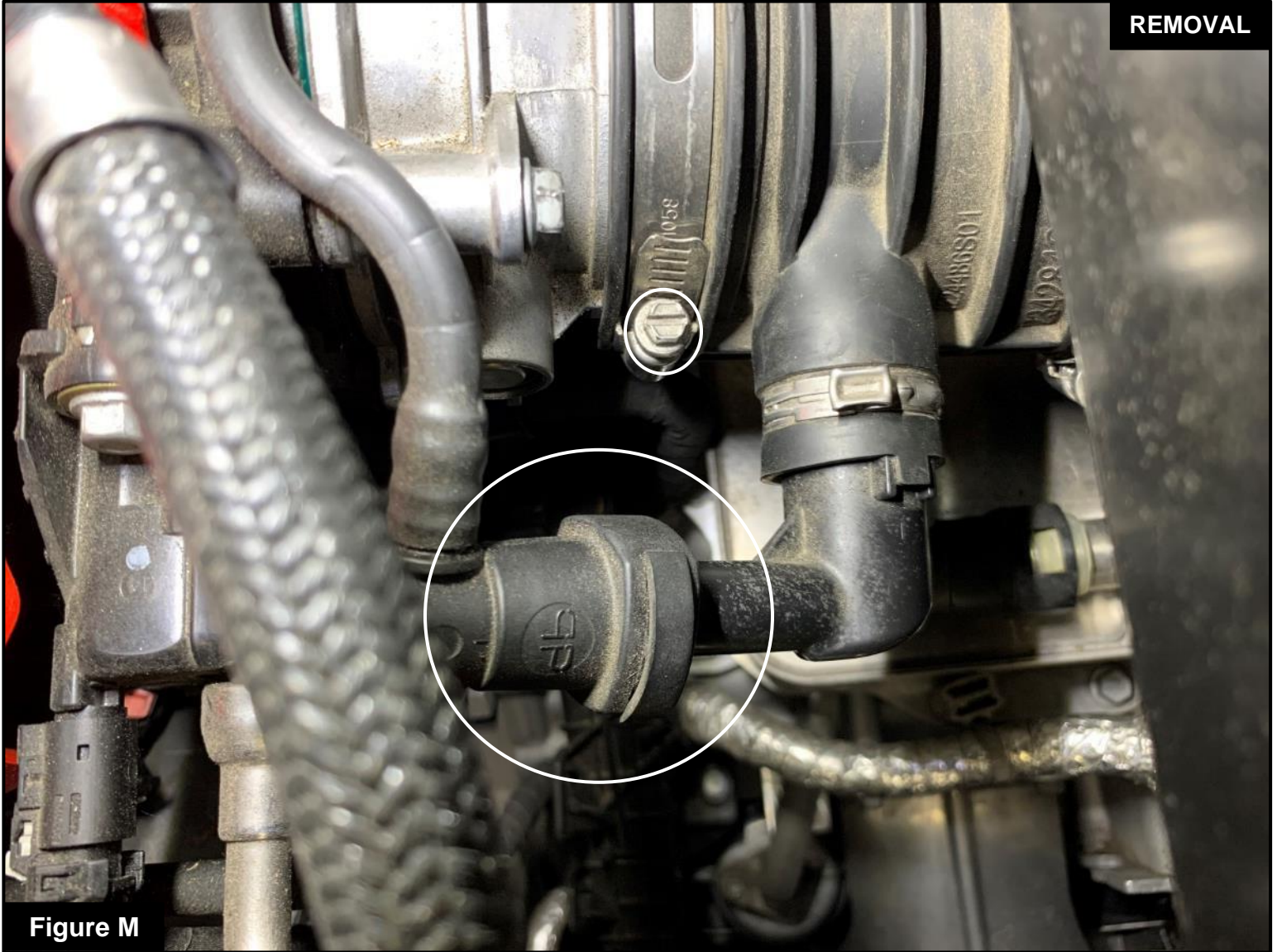

**Figure M**

**Refer to Figure M for Steps 20-21**

Step 20: Disconnect the quick disconnect fitting from the throttle body coupling, by pushing down on the black tab and pulling them apart.

Step 21: Using a 7mm nut driver or flathead screwdriver, loosen the clamp securing the coupling to the throttle body. Then remove the coupling from the vehicle.





**Figure N**

### **Refer to Figure N for Step 22**

Step 22: Remove the 10mm screws securing the air inlet duct on the passenger side of the vehicle and then remove the duct from the vehicle. Repeat this on the driver side. Those screws will be reused.

**Figure O****Refer to Figure O for Step 23**

Step 23: Using a razor blade, slice off the tops of the melted plastic securing the antenna to the airbox. Then gently pull the antenna off of the airbox.

**Note:** The antenna can be reinstalled on the factory airbox using a plastic welding kit.





Figure P

**Refer to Figure P for Steps 24-27**

Step 24: Using a T30 bit, remove the heat shields, these will be reused.

Step 25: Remove the transmission breather, spinning it counter clockwise will unscrew the clip from the threaded insert and eliminate the chance of breaking the push clips.

Step 26: Using a T20 bit, remove the Mass Air Flow sensor and store it in a safe place for now.

Step 27: Remove the ambient air temperature sensor from the front of the airbox.



**Figure Q**

**Refer to Figure Q for Steps 28-31**

Step 28: Remove the 8 screws securing the cover to the housing and open the housing. These screws have thread sealant on them to prevent the screws from loosening. This thread sealant is reusable a few times.

Step 29: Install the heat shields on the aFe POWER airbox, using the provided button head screws and spring lock washers. Pay attention to the orientation of the lock washer, see the drawing on the picture. Tighten with a 4mm hex key. You can also add some teflon tape or reusable thread sealant to prevent the screws from loosening.

Step 30: Install the transmission breather onto the aFe POWER airbox, use the photo to determine the correct hole location.

Step 31: Install the antenna using the provided M4 screws, tighten with a T20 bit.



INSTALL



Figure R

**Refer to Figure R for Step 32**

Step 32: Install the ambient air temperature sensor onto the front of the aFe POWER airbox.



Figure S

**Refer to Figure S for Step 33**

Step 33: Install the aFe POWER inlet ducts onto the vehicle, and secure with the factory 10mm screws.

They are labeled driver and passenger side.

**Note: The aFe POWER ducts can be used as a template to cut a larger air inlet for the intake. This is not required, but will increase airflow.**

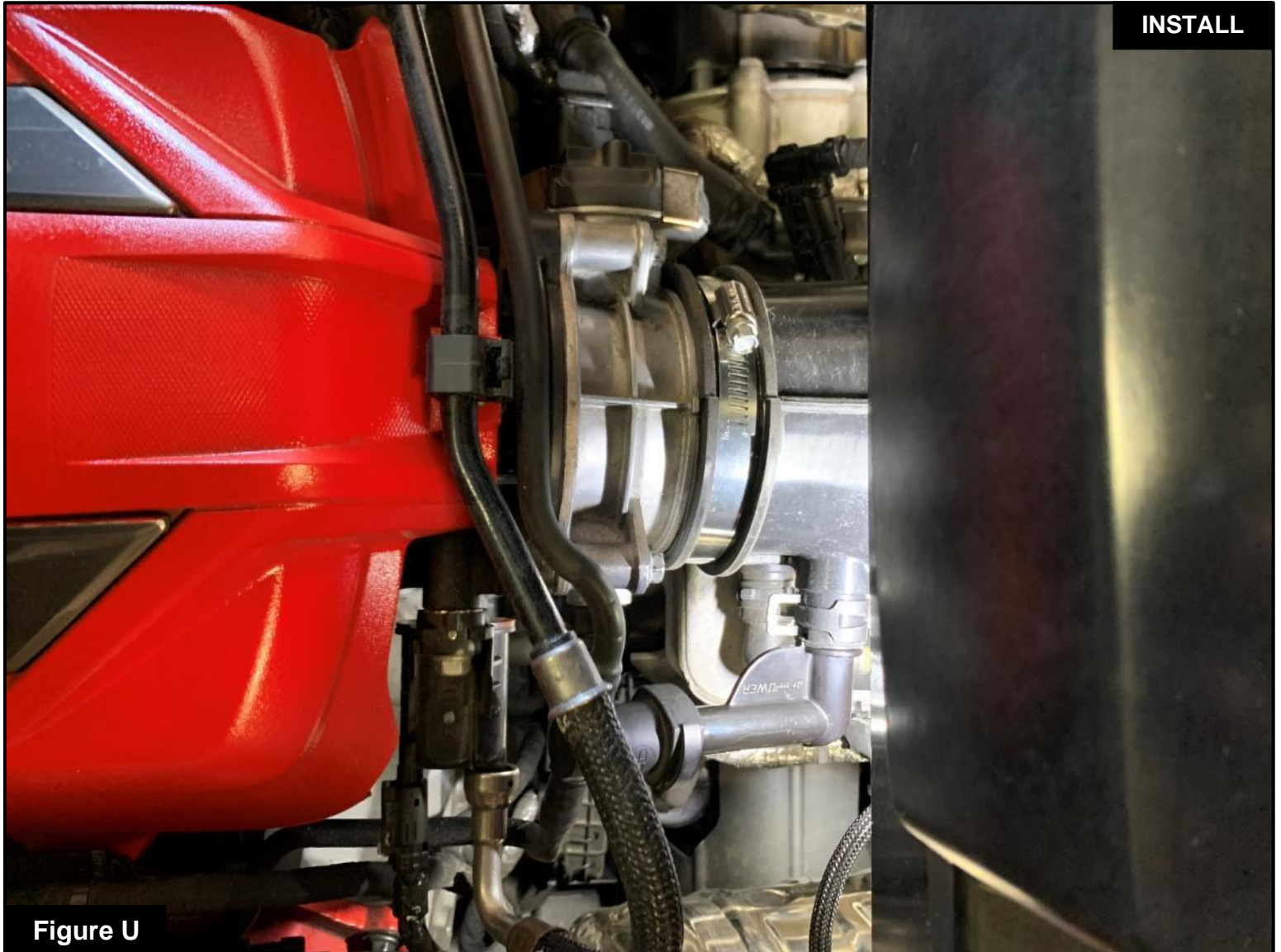

**Figure T****Refer to Figure T for Steps 34-35**

Step 34: Install the plastic fitting into the aFe POWER coupling and secure it with the provided spring clamp.

Make sure the small tab on the fitting is aligned with the notch in the coupling.

Step 35: Loosely place the clamps onto the coupling.



**Figure U**

**Refer to Figure U for Steps 36-38**

Step 36: Install the coupling onto the throttle body. The rib on top of the coupling should be pointing up.

Step 37: Reconnect the quick disconnect fitting to the aFe POWER fitting.

Step 38: Tighten the clamp securing the coupling to the throttle body with a 8mm nut driver or flathead screwdriver.



**Figure V****Refer to Figure V for Step 39**

Step 39: Place the aFe POWER airbox into the vehicle, but do not set it on the mounts yet. Position it so that you can reattach the transmission breather, antenna and the harness push clips on the rear of the housing.

**Note: The brown push clips cannot be installed yet.**

**Figure W****Refer to Figure W for Steps 40-41**

Step 40: Push the housing into its final position and secure it with the (4) factory 10mm screws.

Step 41: Attach the brown push clips to the front of the housing and connect the ambient air temperature sensor. (Three extra christmas tree cable ties are provided if any of the factory christmas tree cable ties get damaged.)





Figure X

### **Refer to Figure X for Step 42**

Step 42: Attach the brown push clips on the engine side of the airbox, on the driver and passenger sides.

Confirm there are no other push clips that need to be attached. (Three extra christmas tree cable ties are provided if any of the factory christmas tree cable ties get damaged.)



### **Refer to Figure Y for Step 43**

Step 43: Install the couplings between the aFe POWER airbox and inlet duct on the driver and passenger sides. Start by putting the coupling inside the airbox and push it outwards into position. Clamps are not required for these couplings.



**Figure Z****Refer to Figure Z for Steps 44-45**

Step 44: Install the silicone sleeve onto the aFe POWER intake tube.

Step 45: Install the Mass Air Flow sensor and secure with provided screws. Tighten with a T20 bit or driver.

**Figure AA**

### **Refer to Figure AA for Steps 46-48**

Step 46: Install the tube into the housing, the sleeve should be fully seated and make sure the tube is correctly seated in the coupling.

Step 47: Tighten the clamp securing the coupling to the intake tube, using an 8mm nut driver or flathead screwdriver.

Step 48: Reconnect the engine harness to the Mass Air Flow sensor.



**Figure AB****Refer to Figure AB for Step 49**

Step 49: Install the air filters onto the intake tube, and tighten the clamps using an 8mm nut driver or flathead screwdriver.





### **Refer to Figure AC for Step 50**

Step 50: Install the aFe POWER cover onto the airbox, and secure with the provided hardware. Tighten the screw to maximum 25 In.-Lbs. (2.8Nm) using a 3mm hex key. The screws have some reusable thread sealant pre-applied to them. If the thread sealant is gone, re-apply some high temperature reusable thread sealant (**Do not use a high strength thread sealant**).





### **Refer to Figure AD for Step 51-53**

Step 51: Reinstall the plastic engine cover with the screws removed at step 5.

Step 52: Reinstall the carpet and roof latches. Secure them with the screws, hooks and clips removed at steps 2, 3 and 4.

Step 53: Reinstall the seal trim surrounding the trunk, removed at step 1.

Your installation is now complete. Verify all connection and screws are secured. Thank you for choosing aFe POWER!



**PAGE LEFT BLANK INTENTIONALLY**





**PAGE LEFT BLANK INTENTIONALLY**



***advanced FLOW engineering, Inc.***

252 Granite Street Corona, CA 92879

<https://afepower.com/contact>